

Wasp HC1







This Quick Start Guide takes you through the basic steps to get your Wasp HC1 up and running. For detailed instructions on any of the topics covered in this Quick Start Guide, and for information on scanning setup barcodes, changing symbologies, power-saving options, scan modes, etc., please refer to the Wasp HC1 Users Manual.

In this Quick Start Guide:

Product Introduction and Accessory Kit.....	2
Front and Right View.....	3
Rear and Left View	4
Turning on the HC1 for the First Time	4
Installing the Battery	5
Charging the Battery	6
Using the MicroSD Memory Card	6
Using the SIM Card	7
Keypads and Function Buttons	8
Using Function Keys.....	9

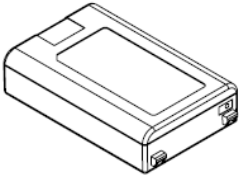
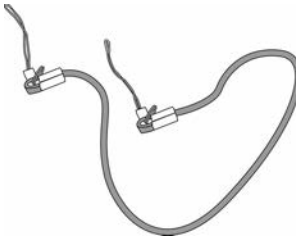
Product Introduction and Accessory Kit

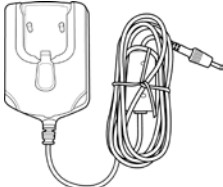
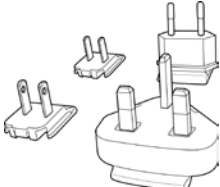
	
<p>HC1 Terminal</p>	<p>Manual CD</p>
	
<p>Stylus</p>	<p>Battery</p>
	
<p>Elastic Stylus String</p>	<p>Hand Strap</p>
	
<p>Power Adaptor</p>	<p>Plugs</p>

Front and Right View

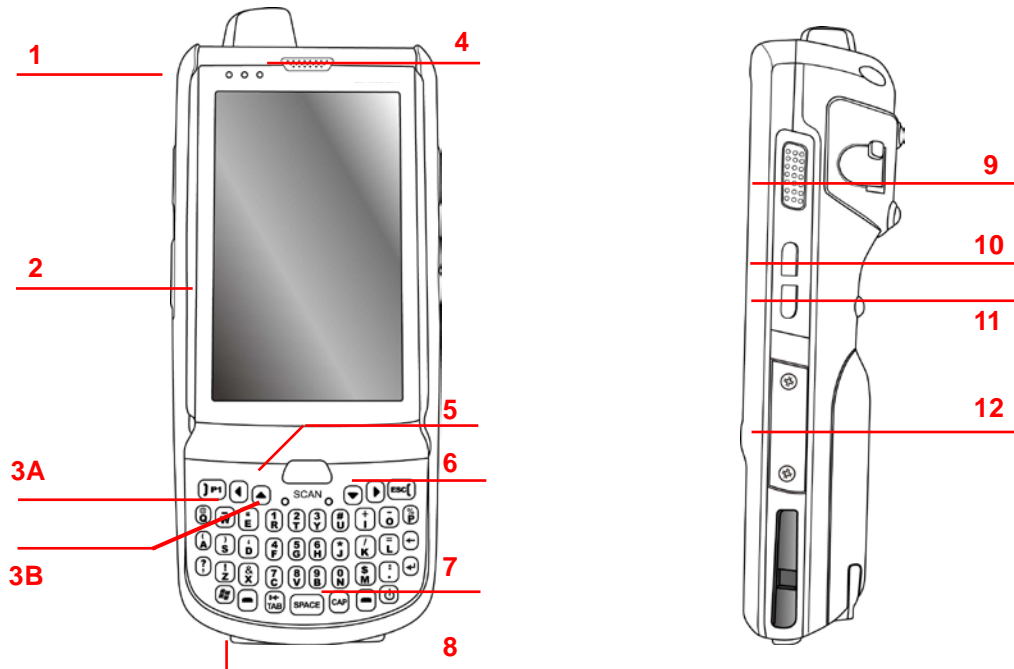

- | | | | |
|----|------------------|----|-------------------------|
| 1 | LED indicators | 7 | Power button |
| 2 | LCD touch screen | 8 | Universal connector |
| 3A | Microphone | 9 | Scanner trigger button |
| 3B | Reset button | 10 | Mute / vibration button |
| 4 | Receiver | 11 | Camera button |
| 5 | Scan button | 12 | Memory card slot |
| 6 | Keypad | | |

Rear and Left View

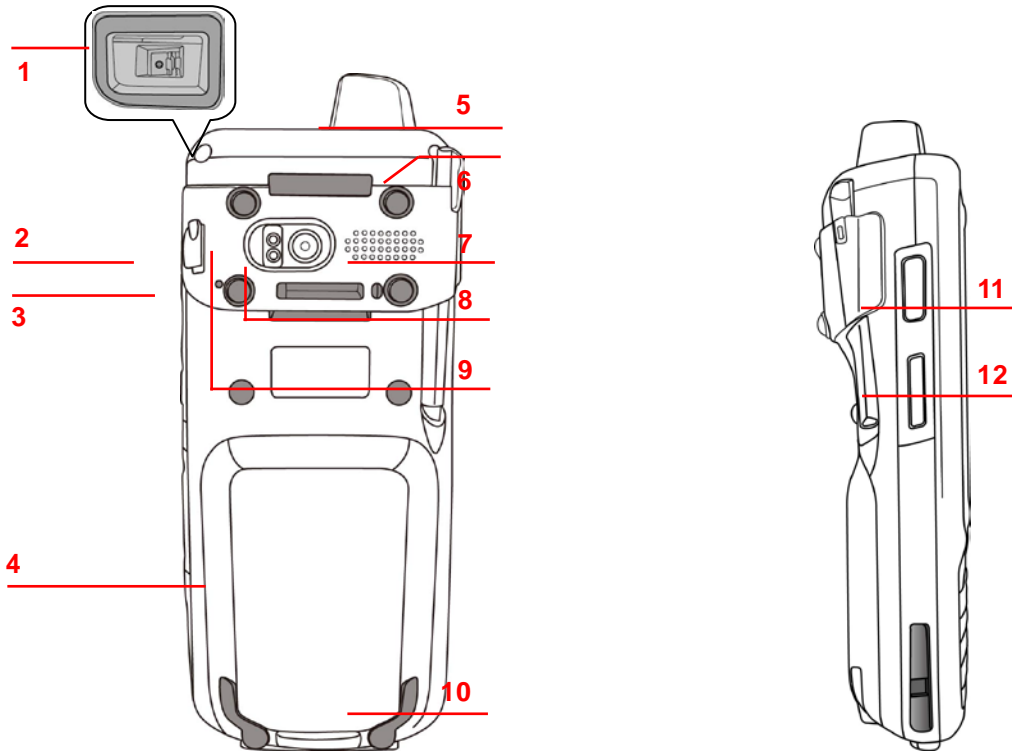

- 1 Barcode scanner window
- 2 Headphone jack
- 3 Microphone
- 4 Battery compartment
- 5 Antenna
- 6 Stylus
- 7 Speaker
- 8 5M/AF camera
- 9 LED flash light
- 10 Battery compartment tab
- 11 Scanner trigger button
- 12 Volume up/down

Turning on the HC1 for the First Time

After you have initially charged your device for about 16 hours, the device is ready to be used. You can now start up your device. You can then calibrate the display, learn some basic stylus usage, and set up the system time zone, date and time.

Power-On Button 

Turn ON your device by pressing the power button on the front panel.

Installing the Battery

1. Open the battery compartment cover by sliding the tabs on both sides in the direction of the arrows shown and lift the cover up.

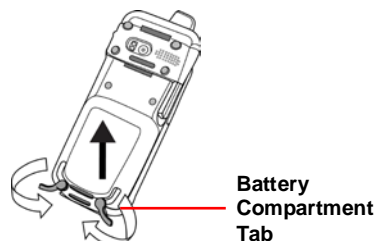

2. Push up the backup battery switch to the "ON" position by using a stylus to turn on the backup battery.

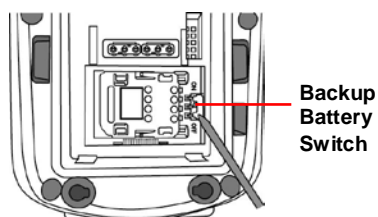

3. Slide and position the battery pack, making sure the battery contacts are aligned with the contacts in the compartment.

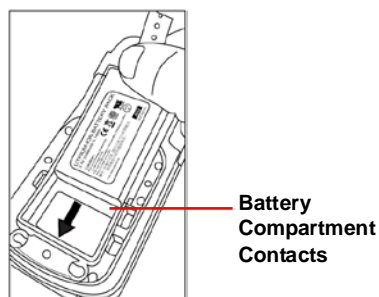

4. Use your thumb to snap the battery down for it to be in place.

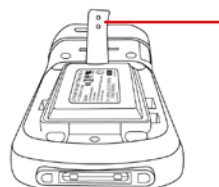

5. Replace the battery compartment cover by pushing down on the tabs and sliding them back into place as shown.

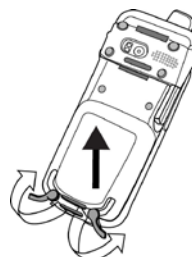

NOTE: Make sure the battery compartment cover is securely closed, or you may be unable to turn ON the terminal.

Charging the Battery

CAUTION: Turn ON the backup battery switch before charging the battery. Data you entered may not be properly stored until the built-in backup battery has been adequately charged.

1. Press and hold the release button on both sides of the USB charging cable and connect it to the HC1 (1).
2. Plug the AC adapter cable into the power jack of the USB charging cable (2).
3. Plug the AC adapter cord into an electrical outlet (3).

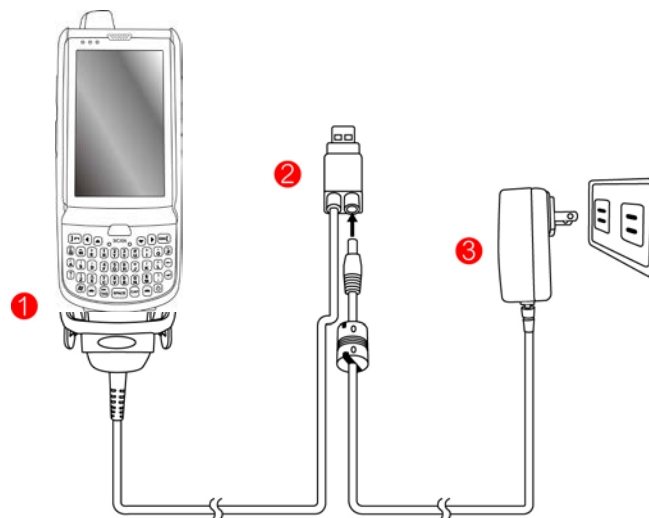

Using the MicroSD Memory Card

1. Remove the two screws on the MicroSD slot shield and remove the shield.
2. Insert the MicroSD card with the notched corner as shown.
3. Push the card into the slot until you feel the MicroSD card click into place.
4. Screw the MicroSD compartment cover back into place.

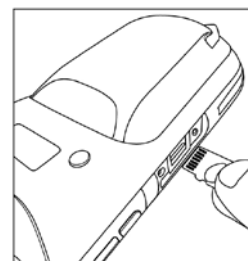
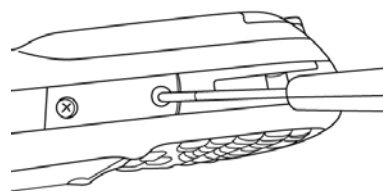

Using the SIM Card

The HC1 has a slot for a GPRS SIM card inside the battery compartment.

CAUTION: Before installing the SIM card, please backup your data to prevent data loss because of a low backup battery.

1. Remove the battery compartment cover and the main battery.
2. Slide the cover of the SIM card slot to the right to release the latch.

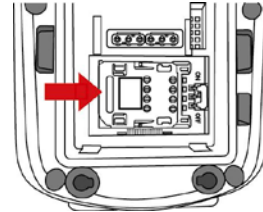

3. Pull open the cover with thumb.

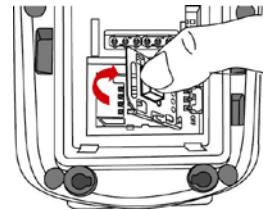

4. Insert the SIM card into the cover with the notched corner up, the contact side of the SIM card facing down.

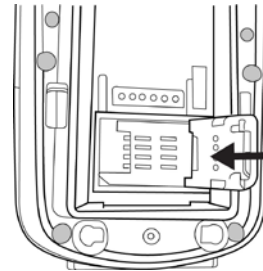

5. Close the cover over the slot, and then slide the cover to the left to lock the SIM card.

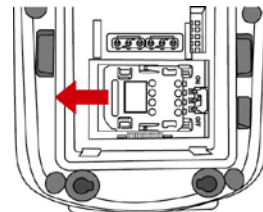

6. Put the battery back into the battery compartment and replace the battery compartment cover.

Keypads and Function Buttons

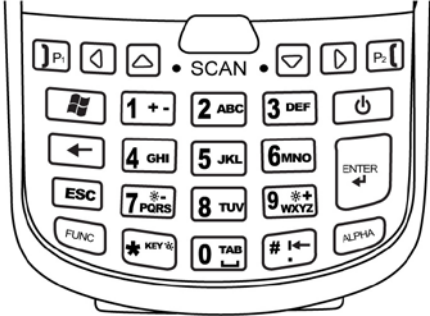

Numeric Keypad



























Qwerty Keypad

Key	Description	Key	Description
	Power key		Escape key
	Enter key		Backspace key
	Tab key		Function key
	Alpha key, toggle between numeric and alphabetic entry modes		Windows key
	Alphanumeric keys		Hang-off key
	Answer key		Left cursor key
	Right cursor key		Up cursor key
	Down cursor key		



























When the HC1 turns on, the numeric mode is on by default. When you toggle to alpha mode, the CAPS mode is off by default. Use the Alpha key to toggle to CAPS.

Using Function Keys











For Qwerty Keypad

Key	Description	Key	Description
 + 	Keypad backlight toggling	 + 	Screen backlight toggling
 + 	Decrease screen backlight brightness	 + 	Increase screen backlight brightness
 + 	Softkey 2	 + 	Softkey 1
 + 	END TALK	 + 	TALK
 + 	Scanner setting	 + 	Task manager execution
 + 	Device information	 + 	Power management

For Numeric Keypad

Key	Description	Key	Description
 + 	Calibration	 + 	Screen backlight toggling
 + 	Keypad backlight toggling	 + 	Power management
 + 	Device information	 + 	Softkey 1
 + 	Softkey 2	 + 	Decrease screen backlight brightness
 + 	Increase screen backlight brightness	 + 	TALK
 + 	END TALK	 + 	Task manager execution
 + 	Scanner setting		

Using Alpha Keys

Key	Alpha Off	Alpha On	
		CAPS Off	CAPS On
	0	Space, @, \$, ", 0	Space, @, \$, ", 0
	1	+, -, \, %, 1	+, -, \, %, 1
	2	a, b, c, 2	A, B, C, 2
	3	d, e, f, 3	D, E, F, 3
	4	g, h, i, 4	G, H, I, 4
	5	j, k, l, 5	J, K, L, 5
	6	m, n, o, 6	M, N, O, 6
	7	p, q, r, 7	P, Q, R, 7
	8	t, u, v, 8	T, U, V, 8
	9	w, x, y, z, 9	W, X, Y, Z, 9
	#	, ; ! . /	, ; ! . /